



MODEL CRSY102
CONDENSATE RECIRCULATING SYSTEM
OPERATIONS MANUAL



PO Box 715
Marietta, OH 45750
800-648-3042 • 740-373-6809
Fax 740-374-3760
www.caronproducts.com
service@caronproducts.com

Dear Valued Customer:

Thank you for purchasing CARON Products & Services equipment. We appreciate your business and look forward to being your preferred supplier of controlled environment equipment products in the future.

At CARON, we are committed to continuous quality improvement. Our goal is to supply our customers with highly reliable equipment at a fair price. In order to openly monitor our performance, we would appreciate your feedback on our products and services.

If you have questions, or any suggestions for improvement based on the installation or operation of the equipment you have purchased, please email us at service@caronproducts.com or contact

Dave Figel, Vice President of Engineering/Operations Phone: 800-648-3042 x216

Jim Lang, Director of Service/Quality

Phone: 800-648-3042 x203

Thanks again for your business!

WARRANTY INFORMATION

EQUIPMENT LIMITED WARRANTY

Please review this section before requesting warranty service. At CARON, one of our primary goals is to provide customers with high levels of personal service and top quality products, delivered on time, backed by technical service and supported for the life of the product.

Before contacting us for warranty service, please be aware that there are repairs that are not covered under warranty.

WARRANTY DEFINED

Caron Products & Services, Inc. (herein after CARON) hereby warrants that equipment manufactured by CARON is free from defects in materials and workmanship when the equipment is used under normal operating conditions in accordance with the instructions provided by CARON.

COVERED:

- Parts and labor for a period of one (1) year from date of shipment.
- Any part found defective will be either repaired or replaced at CARON's discretion, free of charge, by CARON in Marietta, OH. Parts that are replaced will become the property of CARON.
- If CARON factory service personnel determine that the customer's unit requires further service CARON may, at its sole discretion, provide a service technician to correct the problem, or require the return of the equipment to the factory or authorized service depot.
- CARON will have the right to inspect the equipment and determine the repairs or replacement parts necessary. The customer will be notified, within a reasonable time after inspection, of any costs incurred that are not covered by this warranty prior to initiation of any such repairs.

NOT COVERED:

- Calibration of control parameters.
- Improper installation; including electrical service, gas and water supply tubing, gas supplies, room ventilation, unit leveling, facility structural inadequacies or ambient conditions that are out of specification.
- Cost of express shipment of equipment or parts.
- Any customer modifications of this equipment, or any repairs undertaken without the prior written consent of CARON, will render this limited warranty void.
- CARON is not responsible for consequential, incidental or special damages; whether shipping damage or damages that may occur during transfer to the customer's point of use. When the equipment is signed for at the customer's site, ownership is transferred to the customer. Any damage claims against the shipping company become the responsibility of the customer.
- Repairs necessary because of the equipment being used under other than normal operating conditions or for other than its intended use.
- Repair due to the customer's failure to follow normal maintenance instructions.
- Parts considered consumable; including: light bulbs, filters, gases, etc.
- Damage from use of improper water quality.
- Damage from chemicals or cleaning agents detrimental to equipment materials.
- Force Majeure or Acts of God.

This writing is a final and complete integration of the agreement between CARON and the customer. CARON makes no other warranties, express or implied, of merchantability, fitness for a particular purpose or otherwise, with respect to the goods sold under this agreement. This warranty cannot be altered unless CARON agrees to an alteration in writing and expressly stated herein shall be recognized to vary or modify this contract.

Ohio Law governs this warranty.

EQUIPMENT INTERNATIONAL LIMITED WARRANTY

Please review this section before requesting warranty service. At CARON, one of our primary goals is to provide customers with high levels of personal service and top quality products, delivered on time, backed by technical service and supported for the life of the product.

Before contacting your distributor for warranty service, please be aware that there are repairs that are not covered under warranty.

WARRANTY DEFINED

Caron Products & Services, Inc. (herein after CARON) hereby warrants that equipment manufactured by CARON is free from defects in materials and workmanship when the equipment is used under normal operating conditions in accordance with the instructions provided by CARON.

COVERED:

- Parts for a period of two (2) years from date of shipment.
- Any part found defective will be either repaired or replaced at CARON's or their authorized representative's discretion. Parts that are replaced will become the property of CARON.
- If CARON or their authorized representatives determine that the customer's unit requires further service, CARON or the representative may, at its sole discretion, provide a service technician to correct the problem, or require the return of the equipment to the an authorized service depot.
- CARON or their authorized representative will have the right to inspect the equipment and determine the repairs or replacement parts necessary. The customer will be notified, within a reasonable time after inspection, of any costs incurred that are not covered by this warranty prior to initiation of any such repairs.

NOT COVERED:

- Calibration of control parameters.
- Improper installation; including electrical service, gas and water supply tubing, gas supplies, room ventilation, unit leveling, facility structural inadequacies or ambient conditions that are out of specification.
- Cost of express shipment of equipment or parts.
- Any customer modifications of this equipment, or any repairs undertaken without the prior written consent of CARON, will render this limited warranty void.
- CARON and their representative are not responsible for consequential, incidental or special damages; whether shipping damage or damages that may occur during transfer to the customer's point of use. When the equipment is signed for at the customer's site, ownership is transferred to the customer. Any damage claims against the shipping company become the responsibility of the customer.
- Repairs necessary because of the equipment being used under other than normal operating conditions or for other than its intended use.
- Repair due to the customer's failure to follow normal maintenance instructions.
- Parts considered consumable; including: light bulbs, filters, gases, etc.
- Damage from use of improper water quality.
- Damage from chemicals or cleaning agents detrimental to equipment materials.
- Force Majeure or Acts of God.

This writing is a final and complete integration of the agreement between CARON and the customer. CARON makes no other warranties, express or implied, of merchantability, fitness for a particular purpose or otherwise, with respect to the goods sold under this agreement. This warranty cannot be altered unless CARON agrees to an alteration in writing and expressly stated herein shall be recognized to vary or modify this contract.

Ohio Law governs this warranty.

Caron Products & Services, Inc.
PO Box 715 • Marietta, OH 45750
740-373-6809

TABLE OF CONTENTS

Section 1 – Equipment Overview	9
Section 2 – Installation	11
Choosing a Location	
Connecting to Chamber Drain	
Connecting to Chamber Water Supply	
Connecting Electrical Power	
Section 3 – Recirculator Startup.....	15
Filling Reservoir	
Starting Recirculator	
Section 4 – Maintenance	17
Refilling Reservoir	
Replacing Filters	
Replacing Silver Stick	
Replacing UV Light (optional)	
Draining Reservoir	
Section 5 – Preventative Maintenance	24
Section 6 – Brief Troubleshooting.....	25
Section 7 – Spare Replacement Parts	26
Section 8 – Specifications.....	26
Section 9 – Electrical Schematics.....	27
Section 10 – Declaration of Conformity	28

INTERNATIONAL SYMBOLS AND DEFINITIONS



Warning of hazardous area



Warning of dangerous electric voltage



Earth (ground) protective conductor

WARNINGS



Local government may require proper disposal

SECTION 1 – EQUIPMENT OVERVIEW

Congratulations! You have just purchased the latest technology in water recirculator deionization systems. This recirculator is used in conjunction with CARON environmental test chambers. The system provides continuous, clean, filtered water to the chamber's humidity injection system, then collects and recycles the condensate that forms in the base of the chamber.

Before using the equipment, familiarize yourself with key components of the product and thoroughly read this manual.

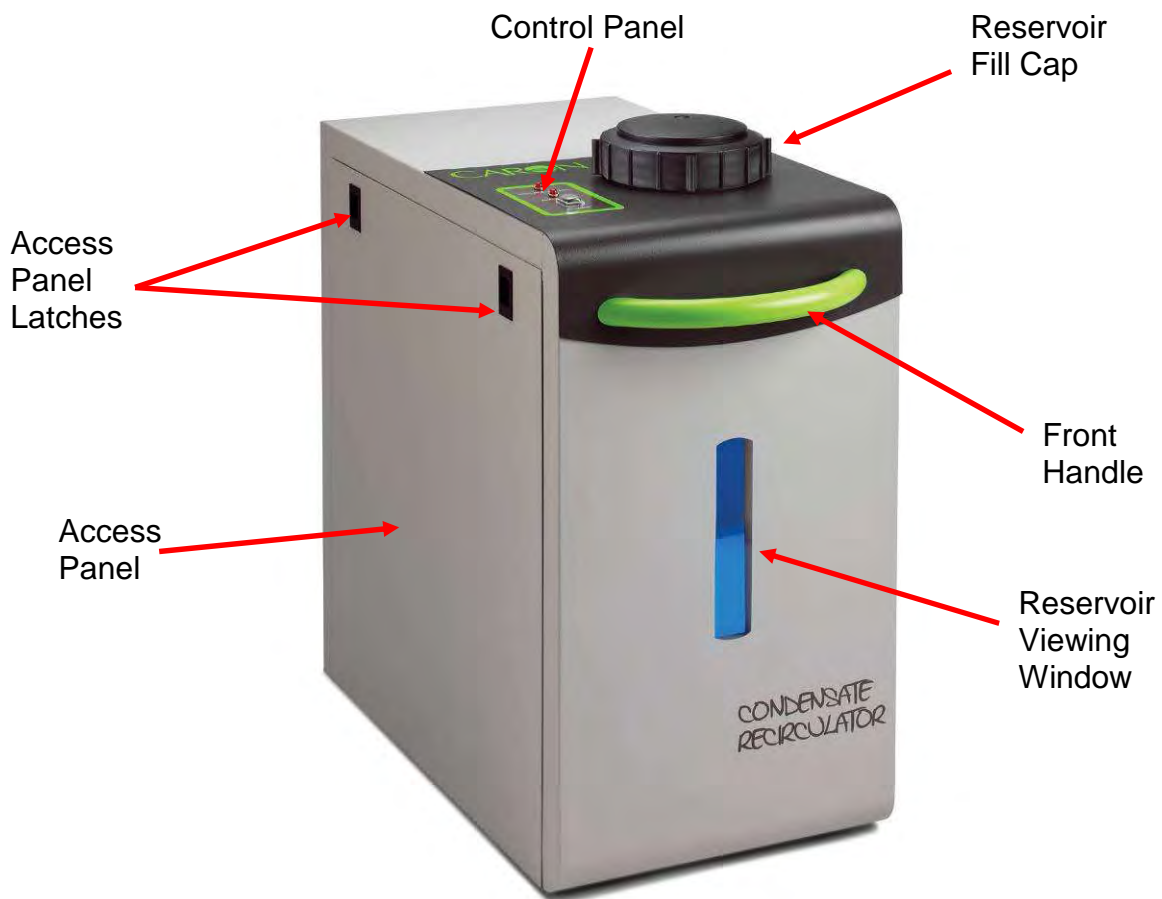

SECTION 1 – EQUIPMENT OVERVIEW (CONTINUED)



SECTION 2 -- INSTALLATION

Choosing a Location

Locate recirculator near the corresponding chamber(s) so recirculator inlet is physically lower than chamber drain(s). This should be a dry, clean, and level area. Locate the unit in an area out of direct sunlight and where the water level viewing window can easily be seen. The unit is on casters for easy mobility. Use the green front and black rear handles to lift the recirculator.



The unit sits low to the ground and can bottom out while moving over bumps.

Connecting to Chamber Drain (Recirculator Inlet)

Connect the chamber drain(s) to the recirculator inlet (3/8" OD, larger fitting connection) using the *blue* tubing and fittings provided. Cut tubing to proper length to ensure the shortest run possible while allowing sufficient tubing slack so the recirculator can be moved (if necessary) and side panels accessed.



Because the chamber drain / recirculator inlet (blue) line is a gravity drain, there can't be any kinks, traps, or vertical rises in the line.



Chamber(s) height may need to be raised for proper drainage.

Connecting to Chamber Water Supply (Recirculator Outlet)

Connect the chamber inlet(s) to the recirculator outlet (1/4" OD, smaller fitting connection) using the *black* tubing and fittings provided. Allow sufficient tubing slack so the recirculator can be moved (if necessary) and side panels accessed.

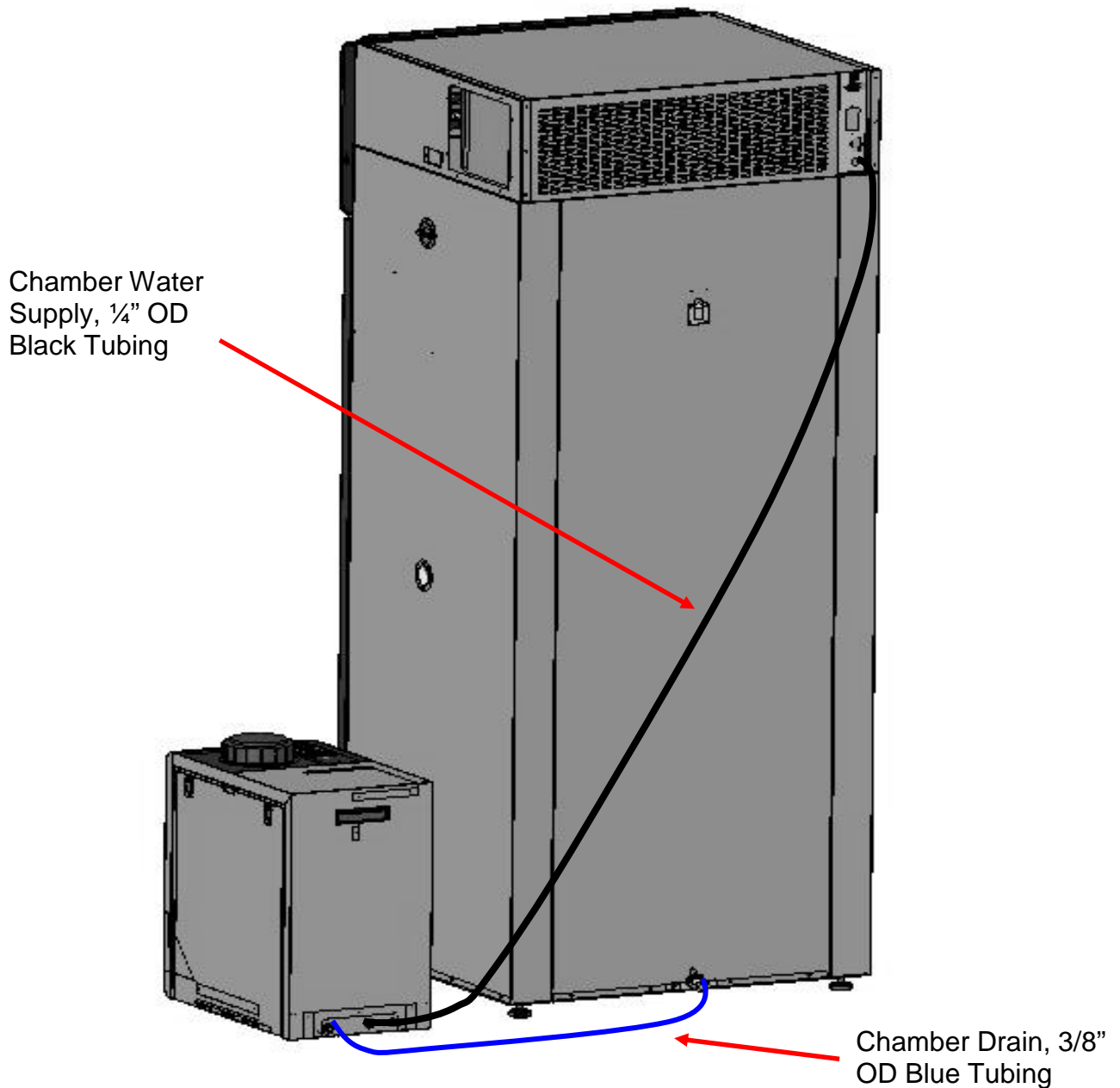

Example of connecting recirculator to single chamber (model 6030 shown)

When connecting the recirculator to two chambers, use the tubing and fittings in the CRSYKIT accessory to make the appropriate connections. The water supply to both chambers should be connected with the ¼" wye fitting and ¼" OD black tubing. The water drain from both chambers should be connected with the 3/8" wye or 3/8" T fitting (whichever allows for a smoother flow of the tubing to prevent vertical rises or traps) and 3/8" blue tubing. A gravity drain must be maintained from both chambers into the recirculator.

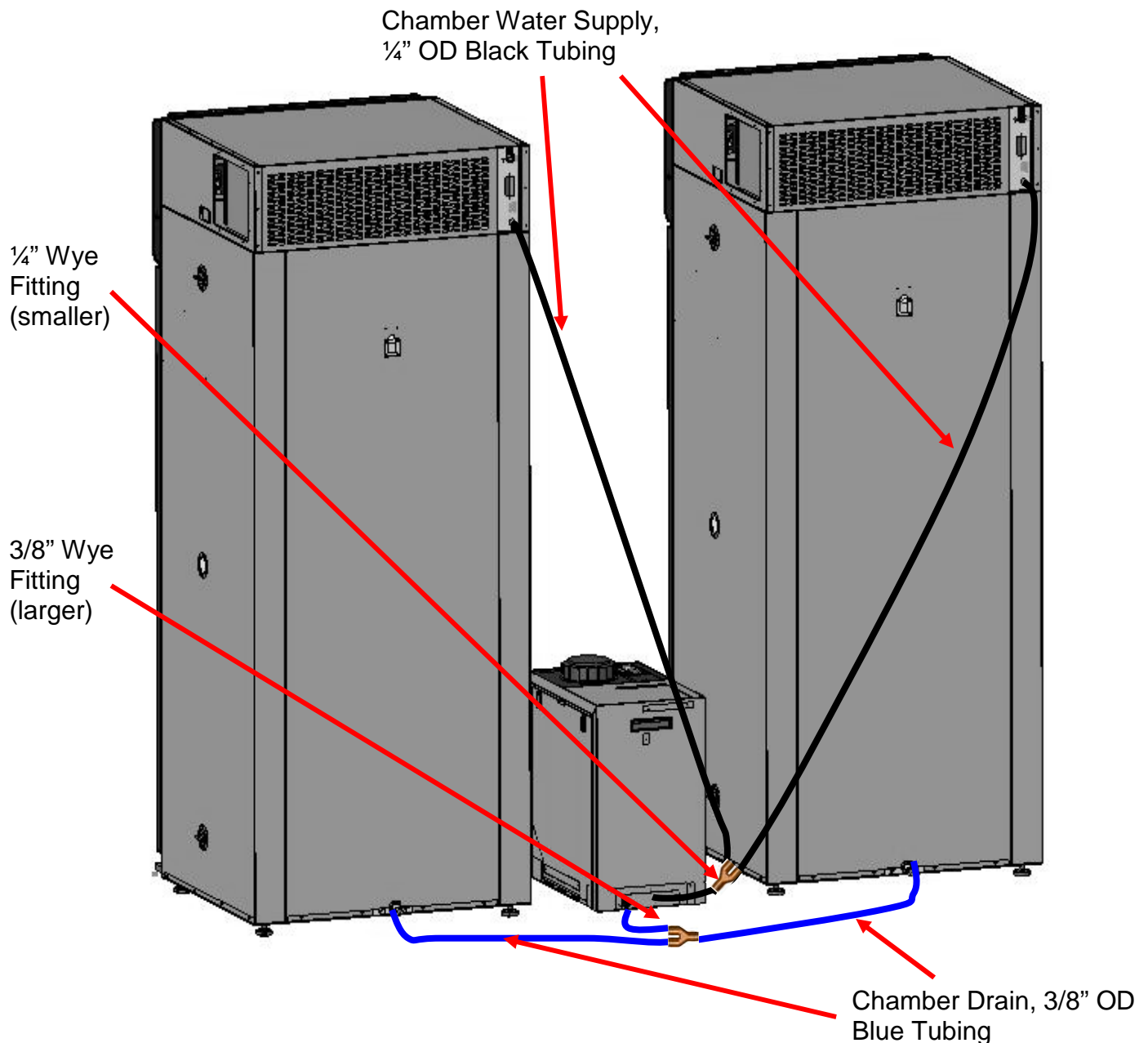

Example of connecting recirculator to two chambers (model 6030 shown) with CRSYKIT.

Connecting Electrical Power



Connect recirculator to a grounded circuit.
Failure to do so could result in electrical shock.

Model CRSY102-1 requires a 115V, 60Hz, 5A power connection. The power cord connection is a NEMA 5-15P plug (Hubbell 5266C). Plug the power cord into the appropriate electrical outlet.



Model CRSY102-4 requires a 230V, 50/60Hz, 2A power connection. The power cord connection is a CEE 7/7 plug. Plug the power cord into the appropriate electrical outlet.



Installing Filters

As shipped from the factory, there are new filters (and silver stick) installed in the recirculator. For spare filters, see the maintenance section.

SECTION 3 – RECIRCULATOR STARTUP



Be sure recirculator outlet is connected before unit is turned on. As soon as the recirculator is turned on, water will begin flowing from the outlet.



When adding water to the reservoir, do not spill onto recirculator.

Filling Reservoir

1. Unscrew reservoir cap.
2. Fill reservoir with water (distilled, deionized or tap). Reservoir holds 7 gallons (26.5 liters).
3. Screw reservoir cap back in place.

Starting Recirculator

1. Turn recirculator power switch on.
 - Reservoir viewing window will illuminate (blue)
 - Replace filter indicator light (red) will blink once
 - Internal air purging process will begin
 - Recirculator outlet will become pressurized
 - Internal water purification cycle will initiate (as necessary)
2. Purge air from chamber(s) water supply line (recirculator outlet) by setting the chamber(s) to high temperature and high humidity set points.



For chamber(s) with internal lights, turn the lights off.

3. Wait a few minutes as water fills the tubing in the chamber
4. Verify the humidity level has increased inside the chamber
5. Set temperature & humidity set points on chamber(s) to desired settings.



Allow the chamber(s) to dry out before turning any internal lights on.

SECTION 4 – MAINTENANCE



When adding water to the reservoir, do not spill onto recirculator.

Refilling Reservoir

The reservoir water level can be monitored through the front viewing window. Additionally, the low water indicator light will illuminate when the reservoir needs refilled. Water can be added to the reservoir while the recirculator is on.



If reservoir water level is too low, it will not supply water to the chamber(s) and proper chamber humidity level may not be maintained.



Before removing access panel(s), disconnect electrical power.

Replacing Filters

1. Turn off recirculator and unplug power cord.
2. If necessary, pull recirculator away from wall.
3. Remove right and left access panels. To remove panels, pull down on the latch tabs and rotate panel outward.



Access Panel
Latch Tabs

4. Remove the filter wrench by unscrewing fastening screw.

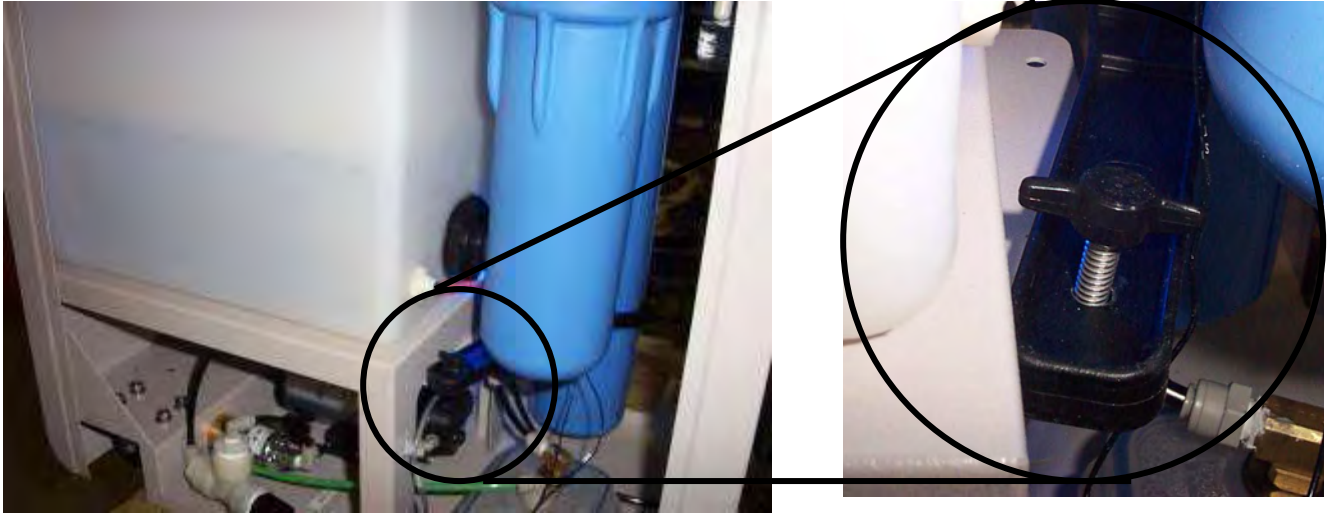

5. Using the filter wrench, unscrew the tall filter housing.

Tall Filter Housing
(Contains DI Cartridge)
on left side of unit



Orientation of the DI cartridge is critical. Orient per instructions on DI cartridge container.



Do not discard o-ring inside of filter housing.

6. Discard used DI cartridge and insert new DI cartridge into tall filter housing.



7. Apply silicone grease to the o-ring.

8. Using the filter wrench, screw tall filter housing back in place until tight (tighten 1/8 turn after hand tight).

9. Using the filter wrench, unscrew the short filter housing.



10. Discard used carbon filter & insert new carbon filter into short filter housing.



Be sure o-ring inside of the filter housing is properly seated.

11. Apply silicone grease to the o-ring.

12. Using the filter wrench, screw short filter housing back in place until tight. (tighten 1/8 turn after hand tight).

13. Install right and left side access panels. Place the panel bottom into each groove and rotate panels upward until latches catch.

14. If necessary, roll recirculator back into place. Do not kink any tubing lines.

15. Plug power cord in and turn recirculator on.

Replacing Silver Stick

1. Unscrew reservoir cap.
2. Retrieve used silver stick from inside reservoir and detach from cable.



3. Insert new silver stick onto cable and place inside reservoir.



4. Screw on reservoir cap.



Before removing access panel(s), disconnect electrical power.



Avoid exposure to direct or reflected germicidal ultraviolet rays. Germicidal ultraviolet rays are harmful to the eyes and skin.

Replacing UV Light (optional accessory)

1. Turn off recirculator and unplug power cord.
2. If necessary, pull recirculator away from wall.
3. Remove left access panel (as viewed from front). To remove panel, pull down on the latch tabs and rotate panel outward.
4. Unclip green wire with ground clip from UV light housing.

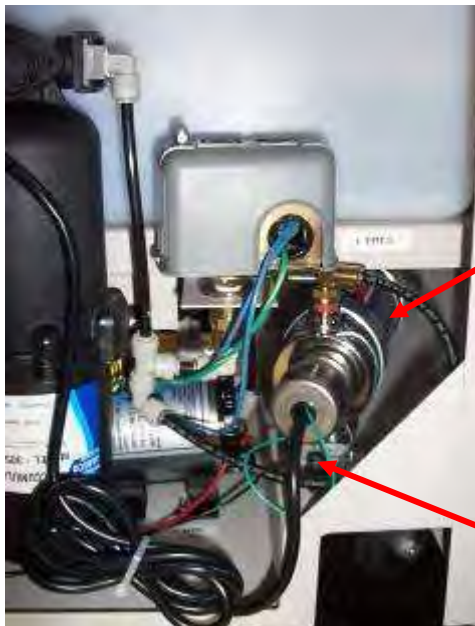

UV Light Housing

Green Wire with Ground Clip

5. Pull UV light housing cap from UV light housing. Connected UV lamp will come out with it.



UV Light Housing Cap

UV Lamp



See separate ultraviolet light owner's manual for specific warnings and instructions.

6. Discard used UV lamp



Follow local regulations for disposing lamps.

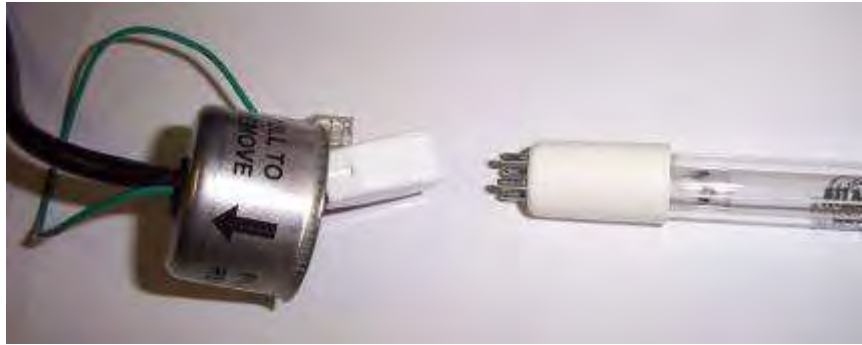

7. Insert new UV lamp into lamp connector socket.
8. Install UV light housing cap (with attached new UV lamp) into UV light housing.
9. Re-attach ground clip.



Ground clip must be securely attached to UV light housing to reduce risk of electrical shock.

10. Install left side access panels. Place the panel bottom into groove and rotate panels upward until latches catch.
11. If necessary, roll recirculator back into place. Be sure not to kink any tubing lines.
12. Plug power cord in and turn recirculator on.



If recirculator is not powered on for more than three days or if it will be subjected to temperatures below freezing, the water should be drained.

Draining Reservoir

The recirculator's internal reservoir can be drained by either of two ways:

1. Turn off recirculator and unplug power cord
2. Remove right side (as viewed from front) access panel
3. Locate ball valve



4. Direct ball valve flow into an empty container and open valve. Because this uses gravity to drain the reservoir, the ball valve must be located below the reservoir.
5. After reservoir is drained, close ball valve and place inside recirculator
6. Install right side access panel.

OR

1. Turn recirculator off
2. Disconnect recirculator outlet line from the chamber
3. Direct recirculator outlet line into an empty container. This is *not* a gravity drain and can be placed at any elevation.
4. Turn recirculator on
5. After water stops flowing, turn recirculator off.

SECTION 5 – PREVENTATIVE MAINTENANCE



Before removing access panel(s), disconnect electrical power.

Electrical components are located in an electrical box. Access is through the left (as viewed from front) access panel. For additional service support, contact your local distributor or CARON service department at service@caronproducts.com.



If recirculator is not powered on for more than three days or if it will be subjected to temperatures below freezing, the water should be drained.



For LGHT601 option, see separate ultraviolet light owner's manual for specific warnings, instructions, and maintenance details.

Routine chamber maintenance is necessary to keep the recirculator working properly.

Recommended Weekly Maintenance Checks

- Check internal fittings for water leaks
- Check large reservoir for debris & algae. Clean if necessary.
- Check small reservoir for debris & algae. Clean if necessary.
- Check chamber drain (recirculator inlet) for blockage, kinks or other restrictions
- Remove standing or splashed water from all surfaces

Recommended Semi-Annual Maintenance Checks

- Replace DI cartridge
- Replace carbon filter
- Replace silver stick
- Replace UV lamp and clean quartz sleeve (feature optional)

Whenever the DI cartridge, carbon filter or silver stick is replaced, it is recommended that they all be replaced at the same time.

SECTION 6 – BRIEF TROUBLESHOOTING

Reservoir viewing window does not illuminate (blue)

- Is recirculator plugged in?
- Is the power switch turned on?
- Has the recirculator circuit breaker tripped? See resetting circuit breaker.
- Is there water in the reservoir? Add water light will be on.



The recirculator must be powered on to prevent returning condensate (water from chamber) from overflowing inside the recirculator.

Water is leaking from unit

- Is the recirculator on?
- Has a power failure recently occurred?
- Are the filter housings tight?
- Is the o-ring in the filter housing properly seated?
- Is the internal reservoir drain valve open?
- Is the recirculator water outlet connected properly to the chamber?

Water is not draining properly from the chamber(s) to the recirculator

- Is the recirculator physically lower than the chamber(s)?
- Is the chamber drain line (recirculator inlet) kinked? Plugged? Have a rise?
- Is the recirculator off?

It is part of the normal operation for

- The blue reservoir light to flicker
- Water to flow into the reservoir producing a splashing and stirring motion
- The red Replace Filters indicator light to flash at startup

SECTION 7 – SPARE / REPLACEMENT PARTS

Replacement Parts

Part Number	Description
CRSYKIT	Tubing & fitting kit for connection to 2 chambers
DEM-103	DI cartridge, #20
FIL-607	Carbon filter, #10
FLTR101	Filter replacement kit for CRSY102. Kit includes (1) DEM-103, (1) FIL-607, (1) HUM-113
HUM-113	Ionic silver stick
LGT-134	UV lamp, replacement bulb for LGHT601 option
TUB-132	1/4" tubing
TUB-168	3/8" tubing
GAS-114	Filter o-ring
SIL-111	O-ring sealant
WRN-102	Filter wrench

To order replacement parts, contact CARON's service department at 740-373-6809 or service@caronproducts.com.

SECTION 8 – SPECIFICATIONS

Model	CRSY102-1	CRSY102-4
Water Purity*	100 to 125 kΩ-cm	
Water Reservoir	7 gallon (26.5 L)	
Exterior Dimensions	14" W x 26.5" D x 26.6" H (35.5cm W x 67.3cm D x 67.6cm H)	
Exterior Construction	Cold Rolled Steel, Powder Coated	
Electrical	115V, 60Hz, 5A NEMA 5-15P Plug	230V, 50/60Hz, 2A CEE 7/7 Plug
Shipping Weight	125 lbs. (57 kg)	200 lbs. (91 kg)

* Water purity measured internally
Specifications are subject to change without notice.

SECTION 9 – ELECTRICAL SCHEMATICS

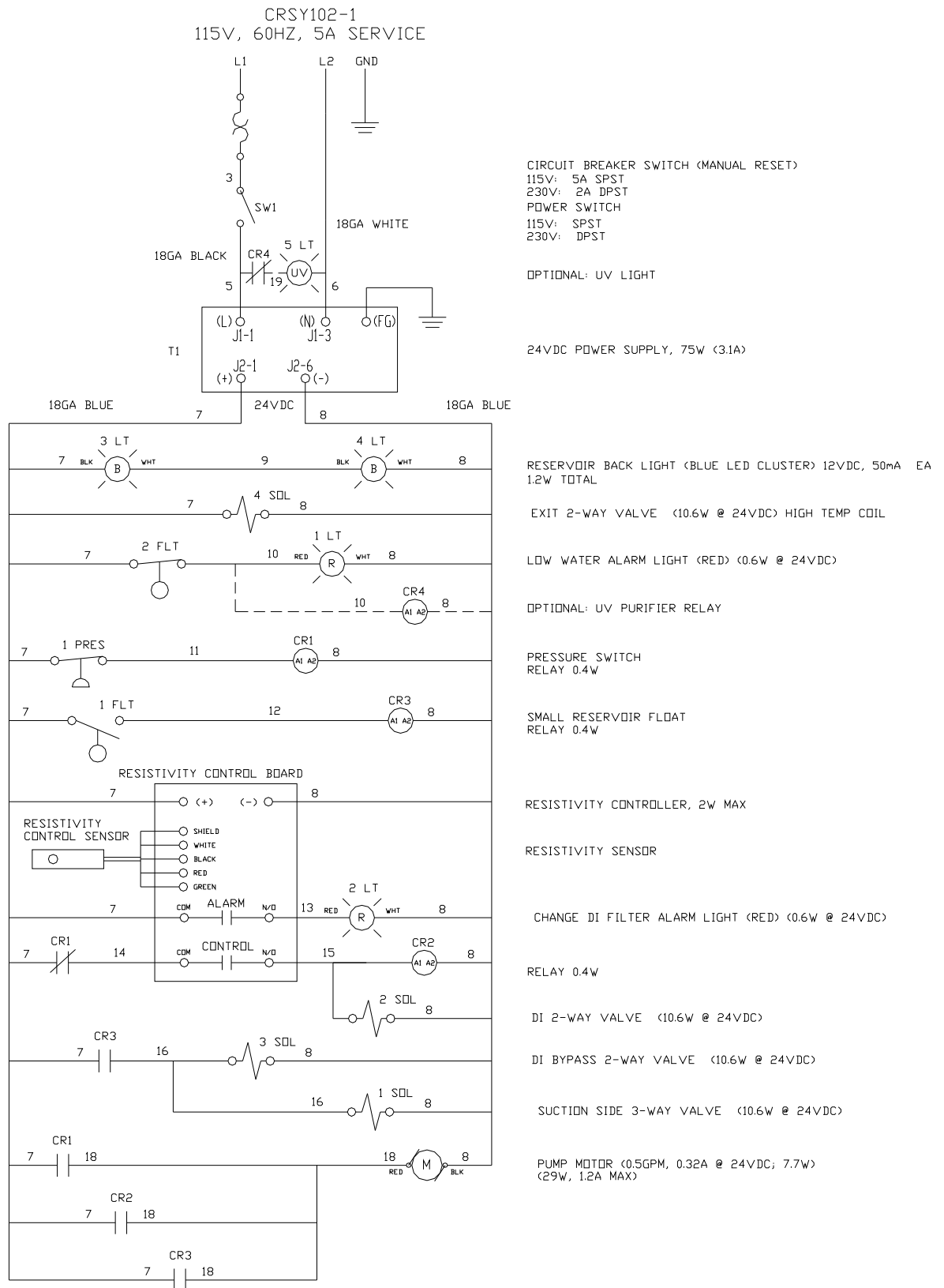

SECTION 10 – DECLARATION OF CONFORMITY



CE Compliant Product

Declaration of Conformity

Caron Products
27640 State Route 7
Marietta, OH 45750 USA

Declares that the following product:

Designation: CRSY102
Model Number: CRSY102-4
Classification: Electrical Equipment for Measurement, Control, & Lab Use
Rated Voltage: 220-240 V~ (ac)
Rated Frequency: 50/60Hz
Rated Power Consumption: 2 amps

Meets the essential requirements of the following European Union Directive(s) using the relevant section(s) of the normalized standards and related documents shown:

89/336/EEC Electromagnetic Compatibility Directive

EN 61326:1997	Laboratory Equipment, Immunity Measurement & Control requirements
EN 61000-4-2:1995	Electrostatic Discharge
EN 61000-4-3:1995	Radiated Susceptibility
EN 61000-4-4:1995	Electrical Fast Transient
EN 61000-4-5:1995	Lightning Surge
EN 61000-4-6:1996	Conducted Disturbances Induced by RF Fields
EN 61000-4-11:1994	Voltage Variations, Dips and Interruptions
CISPR 11:1990	Emissions Standards

73/23/EEC Low-Voltage Directive

EN 61010-1:2001	Safety requirements for electrical equipment for measurement, control, and laboratory use.
-----------------	--